

1 5/8-8 UN
FOR JACK BOLT

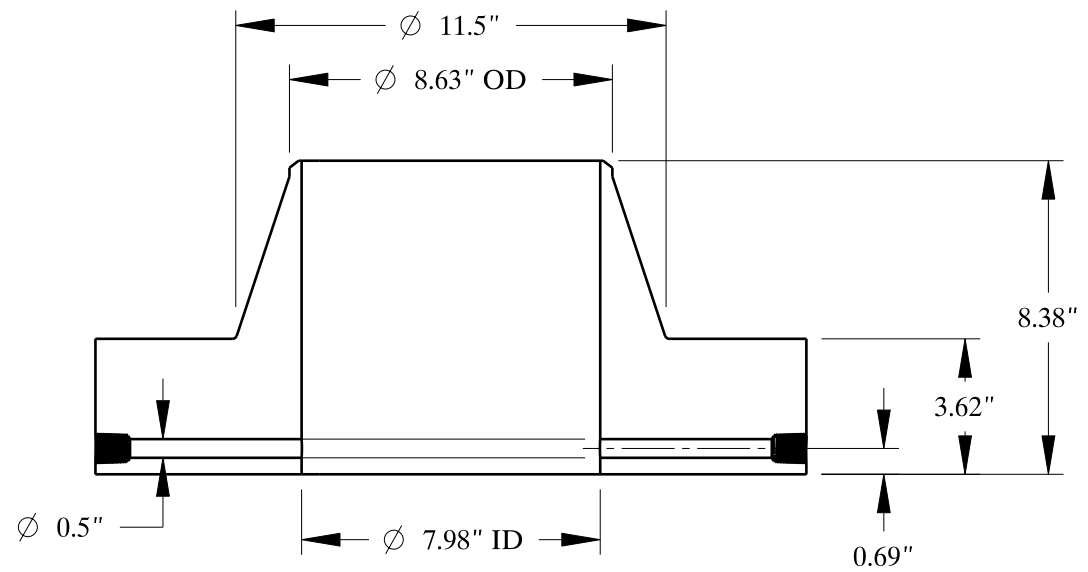
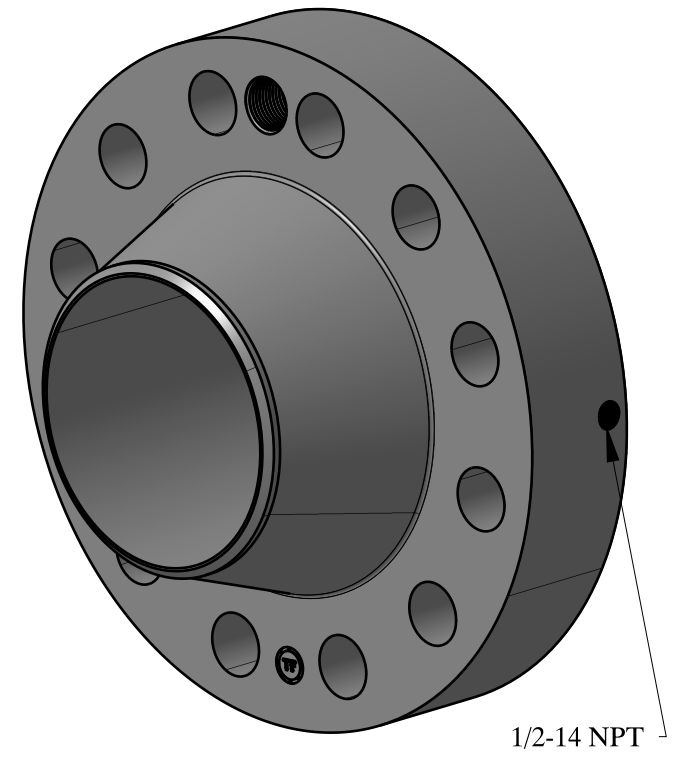
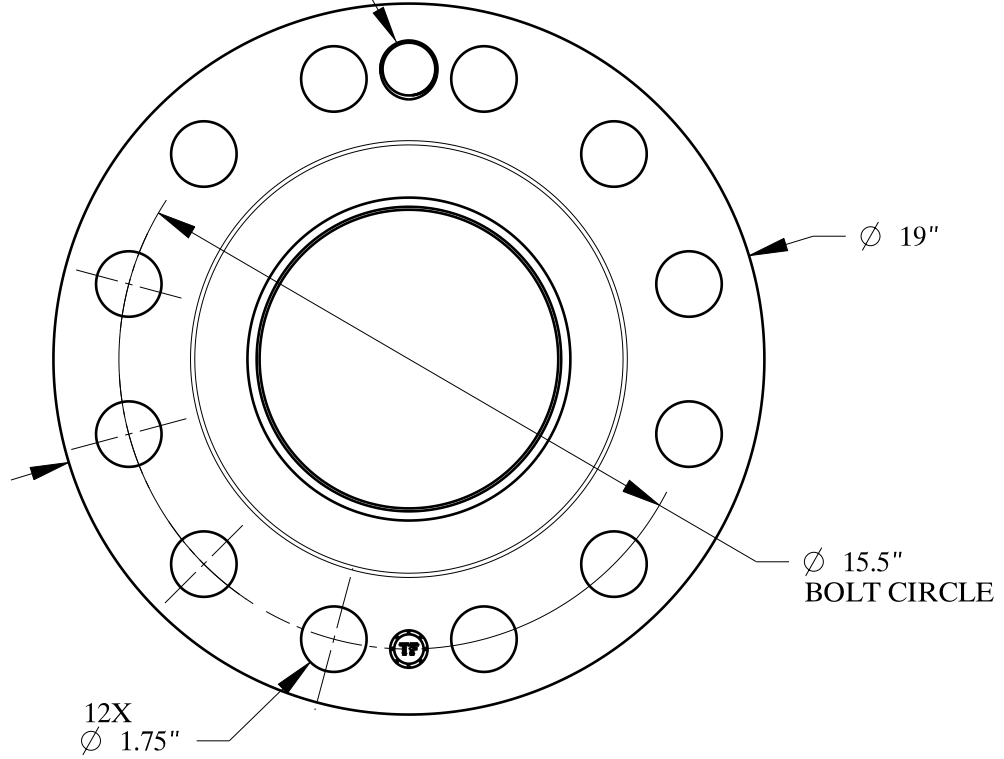

SIZE:	8" NOM. X SHC: 40
TYPE:	1500-FF-WELD-NECK-ORIF-FLANGE
	Texas Flange
PO Box 2889 Pearland, TX 77588 PH: 800-826-3801 FAX: 281-484-8730 www.texasflange.com	