

1 1/2-6 UNC
FOR JACK BOLT

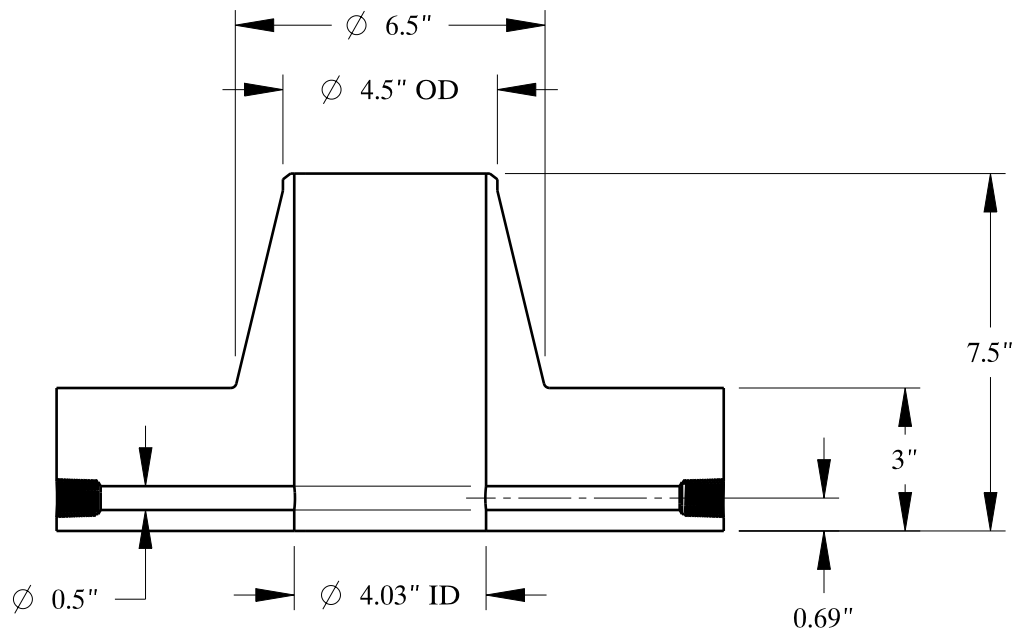

SIZE: 4" NOM. X SHC: STD
TYPE: 2500-FF-WELD-NECK-ORIF-FLANGE

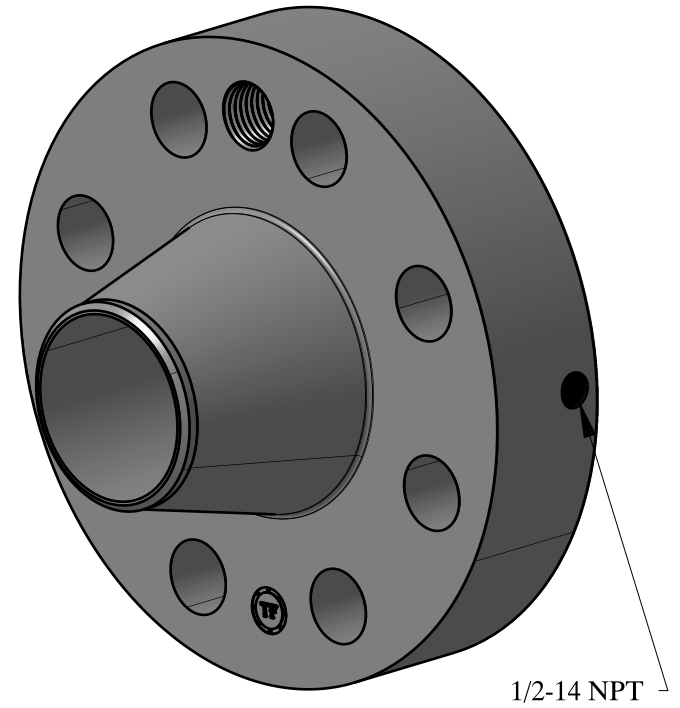
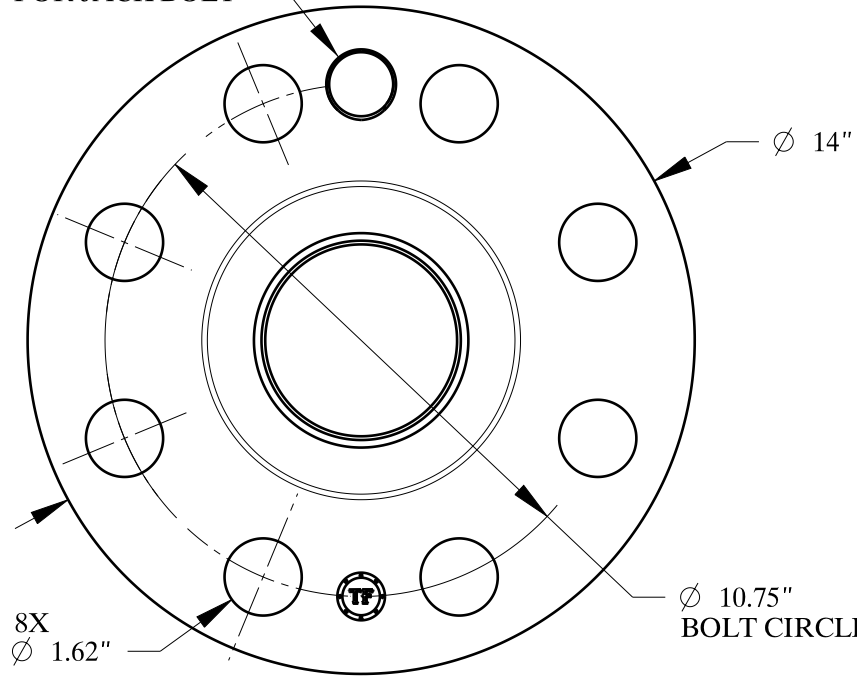

**Texas
Flange**

PO Box 2889
Pearland, TX 77588
PH: 800-826-3801
FAX: 281-484-8730
www.texasflange.com