

1 7/8-8 UN
FOR JACK BOLT

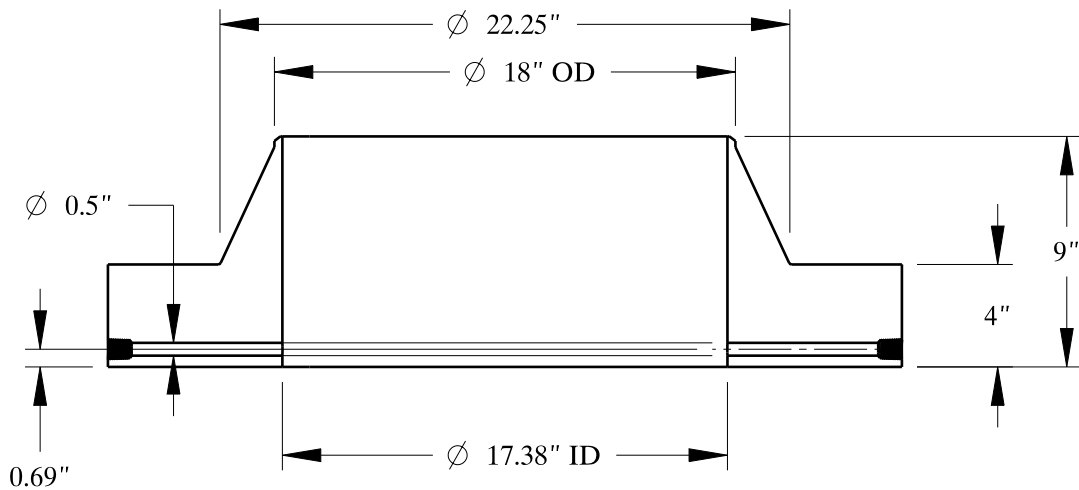
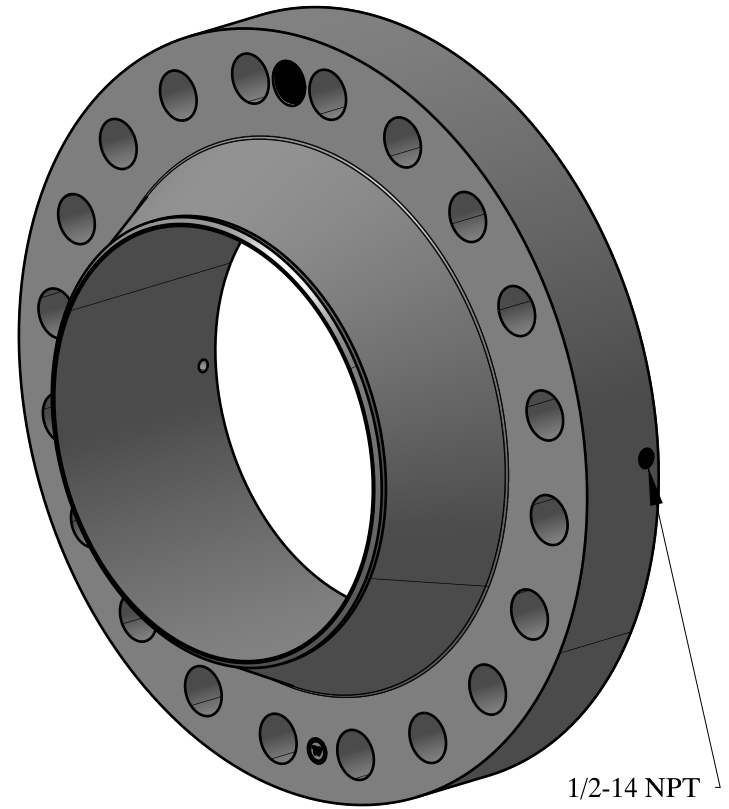
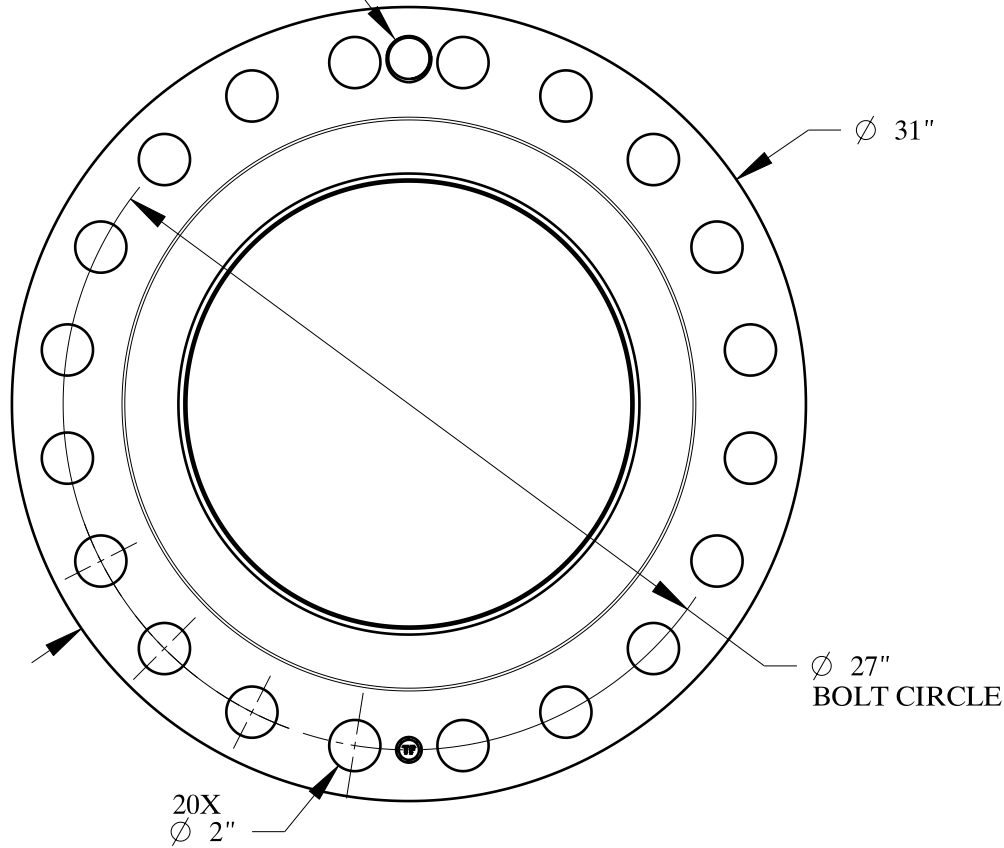

SIZE:	18" NOM. X SHC: 20
TYPE:	900-FF-WELD-NECK-ORIF-FLANGE
 Texas Flange	
PO Box 2889 Pearland, TX 77588 PH: 800-826-3801 FAX: 281-484-8730 www.texasflange.com	