

Ø 17.75"  
BOLT CIRCLE

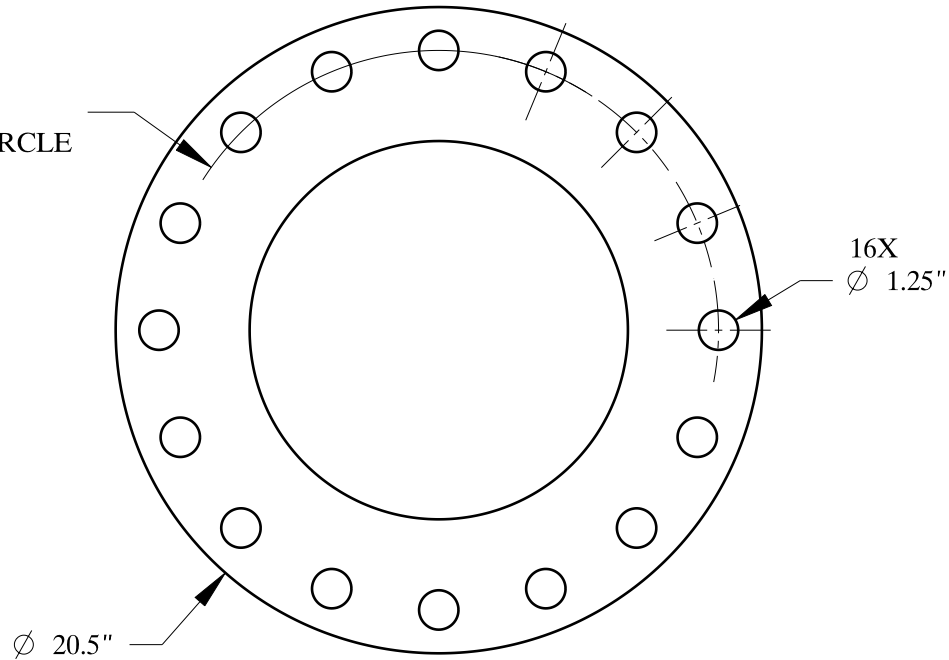

16X  
Ø 1.25"

Ø 20.5"

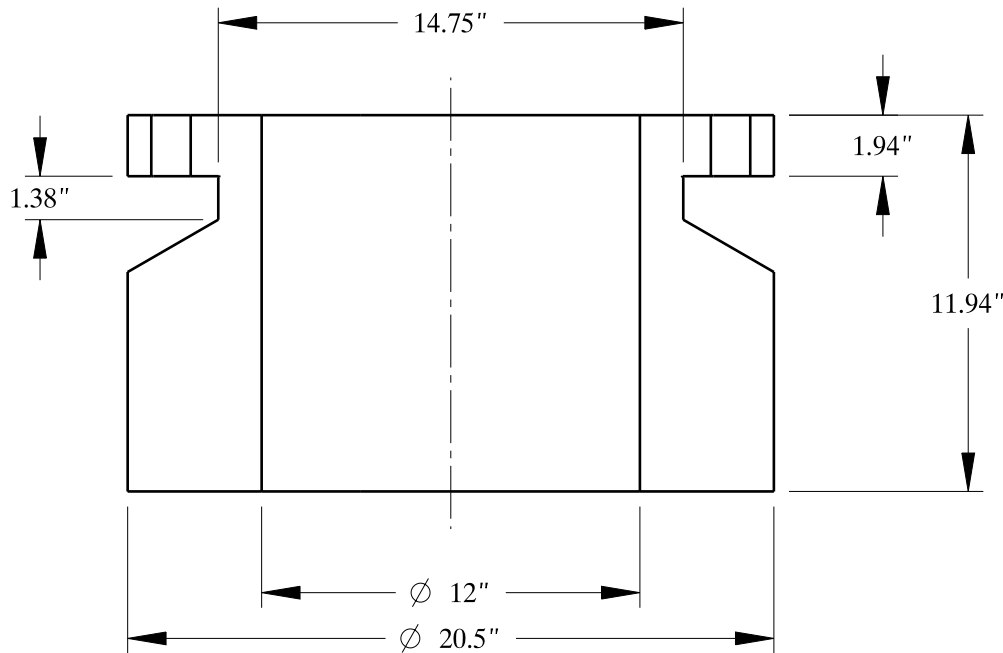
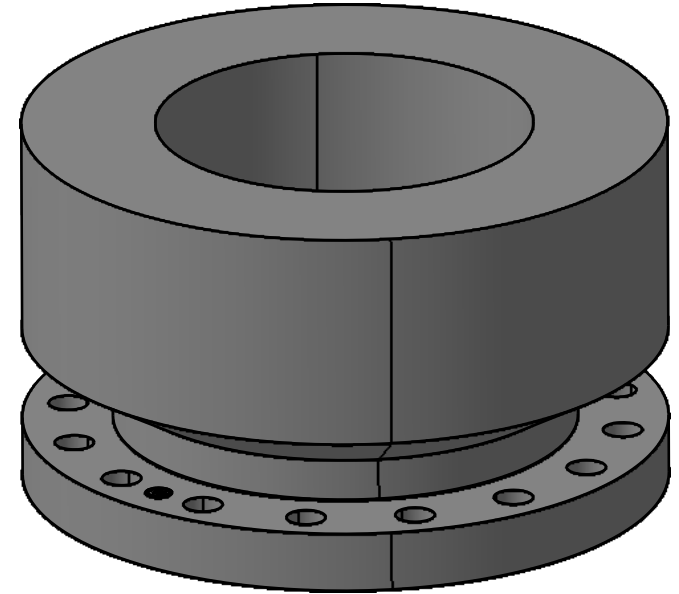

SIZE: NOM. PIPE SIZE 12 INCH  
TYPE: 300-EB-FF-STD-CONN-FLANGE

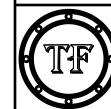

**Texas  
Flange**

PO Box 2889  
Pearland, TX 77588  
PH: 800-826-3801  
FAX: 281-484-8730  
www.texasflange.com