

2 1/2-4 UNC
FOR JACK BOLT

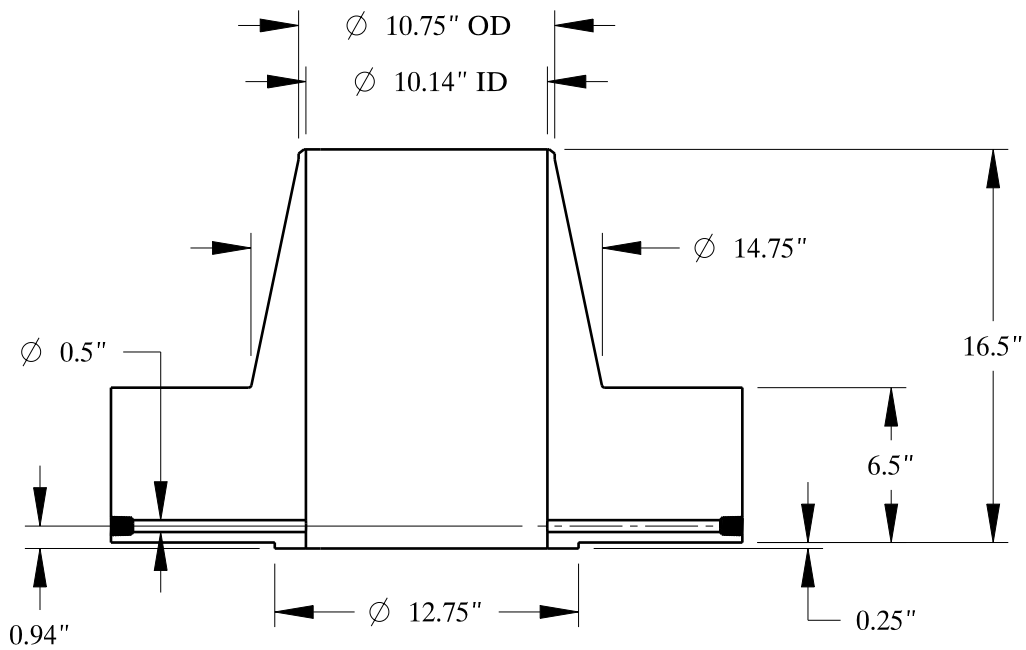
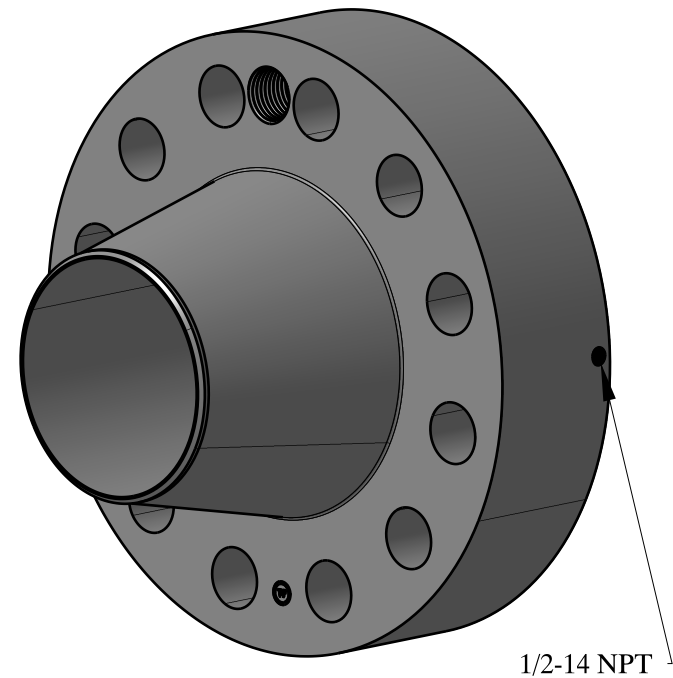
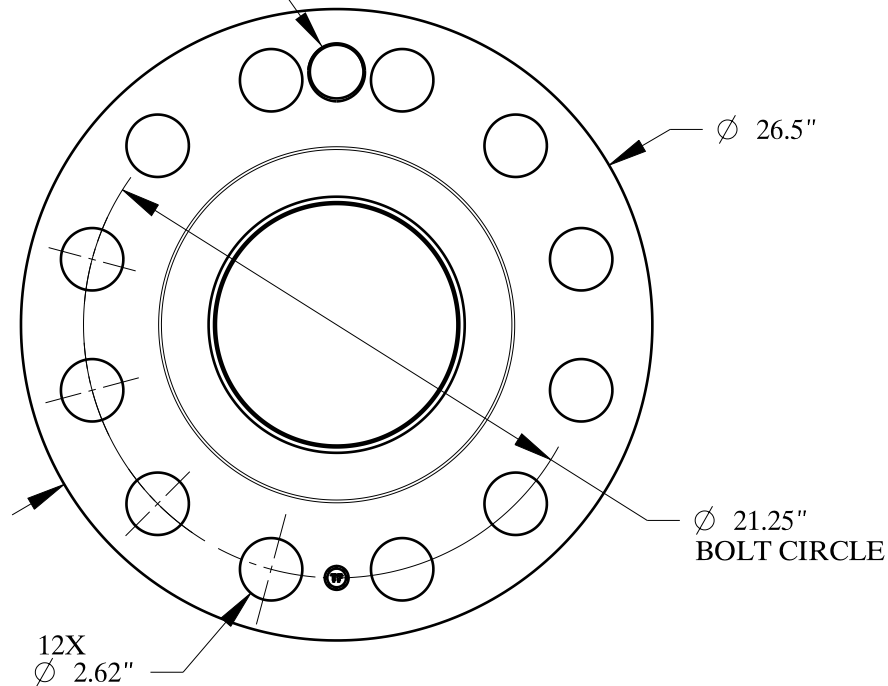

SIZE:	10" NOM. X SHC: 30
TYPE:	2500-RF-WELD-NECK-ORIF-FLANGE
	Texas Flange
PO Box 2889 Pearland, TX 77588 PH: 800-826-3801 FAX: 281-484-8730 www.texasflange.com	