

1 7/8-8 UN
FOR JACK BOLT

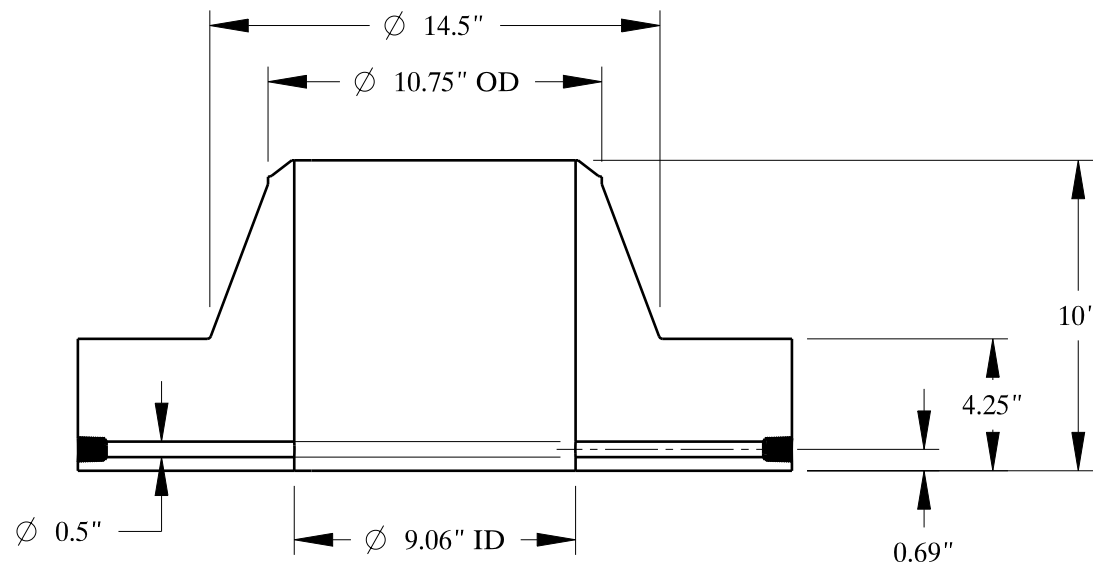

SIZE: 10" NOM. X SHC: 120
TYPE: 1500-FF-WELD-NECK-ORIF-FLANGE

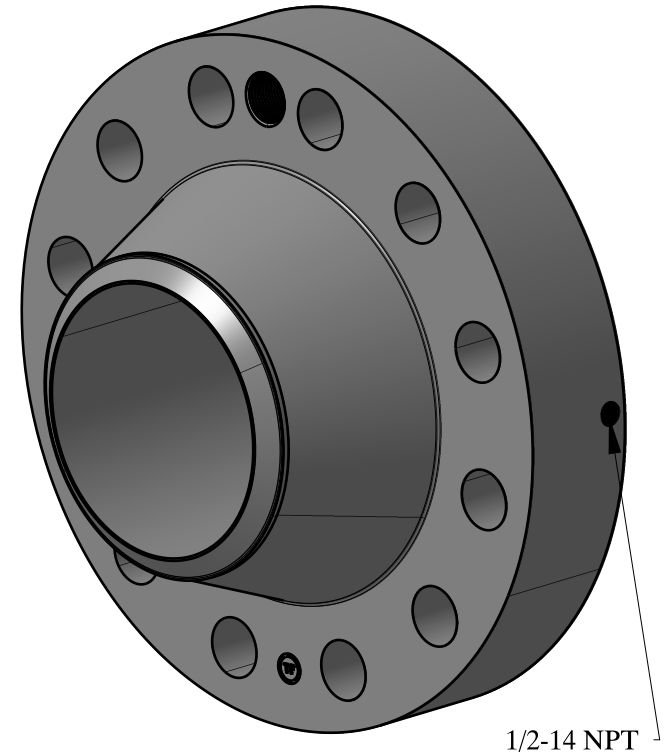
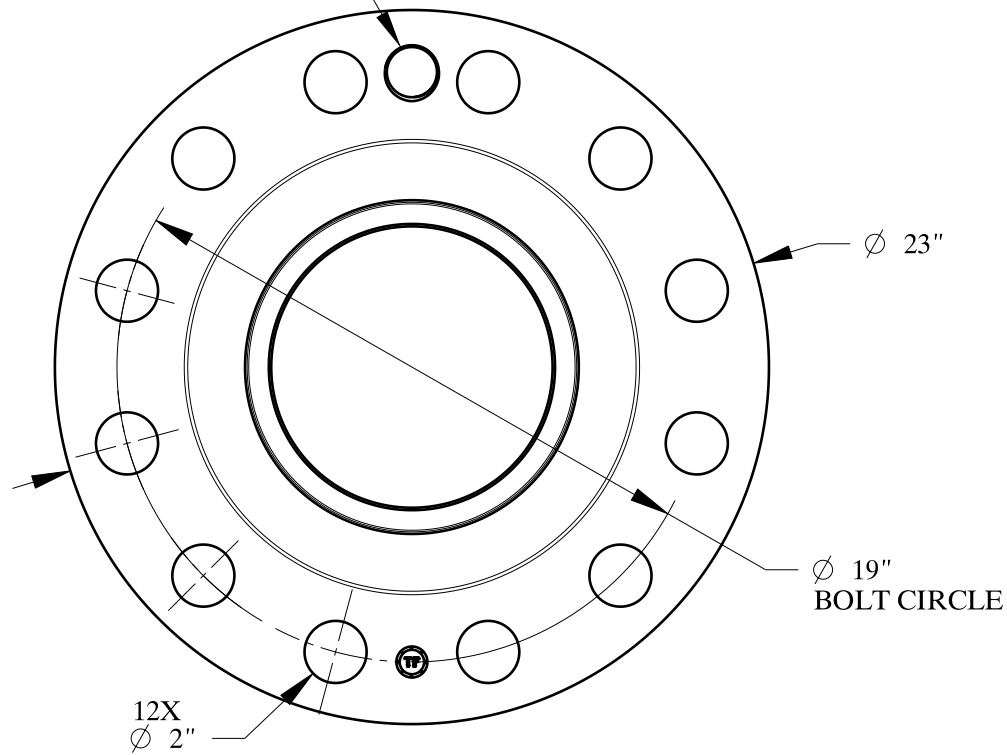

**Texas
Flange**

PO Box 2889
Pearland, TX 77588
PH: 800-826-3801
FAX: 281-484-8730
www.texasflange.com