

1/2-14 NPT

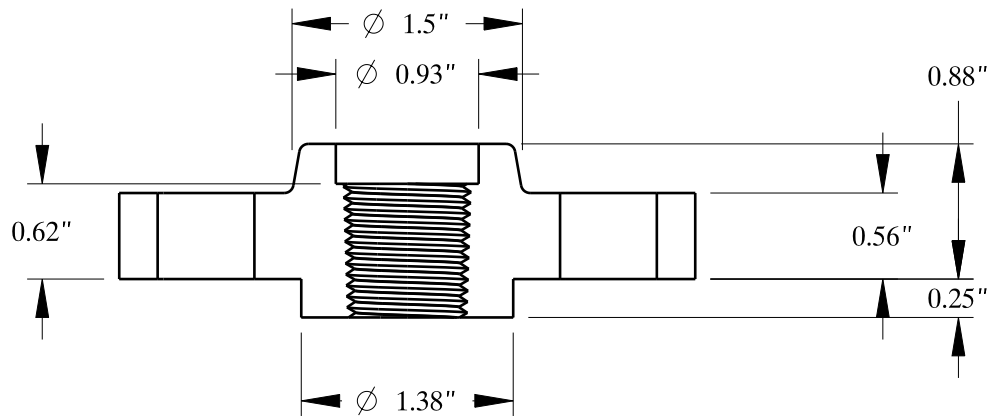
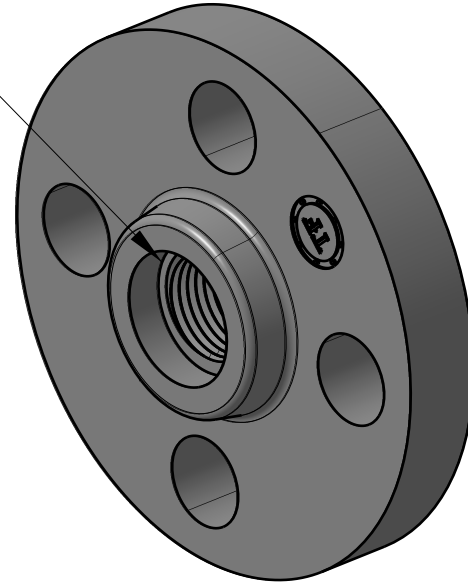

SIZE: $\frac{1}{2}$ " NOM. PIPE
 TYPE: 400-THREADED-RF-FLANGE

Texas Flange
 PO Box 2889
 Pearland, TX 77588
 PH: 800-826-3801
 FAX: 281-484-8730
www.texasflange.com